

PMG-WG T - TAC - B5

Permanent Magnet Generator for Wind Microturbines



PMG-WG is a high efficiency generator for wind turbines, manufactured with permanent magnets (Nd-Fe-B) in order to obtain high power density and very compact size.

NSM's experience and accurate tests have allowed us to develop a product with very low cogging, so that the wind turbine spins even with minimum wind speed.

Current range includes micro wind generators that can supply continuous output power from 1,2 to 6kVA, with a high overload capacity (max kVA) for a limited time span.

On request, NSM can develop highly customized solutions.

These configurations consist in an inner wound stator (fixed part) and an outer rotor with magnets (rotating part), ready for direct drive application.

Technical characteristics

Standard voltage

PMG-WG 185: 380V

PMG-WG 295: 400V

Other voltages on request

Insulation class H

Protection IP 55

Model	Power [kVA]	Max Power [kVA]	Cogging [Nm]	rpm	Weight		
					T [kg]	TAC [kg]	B5 [kg]
PMG-WG 185SC	1,2	1,8	< 0,60	415	22,5	27	41
PMG-WG 185MA	2	3,6	< 1,20	415	31,5	35,5	49
PMG-WG 185LA	4	5,8	< 1,60	415	40	43,5	60
PMG-WG 185XLB	6	9,5	< 3,20	415	---	70	100
PMG-WG 295H	3	3,9	< 5,00	150	82	---	---
PMG-WG 295P	6	8,5	< 7,50	150	123	---	---

Overall Dimensions

T

PMG-WG 185

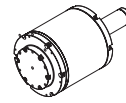
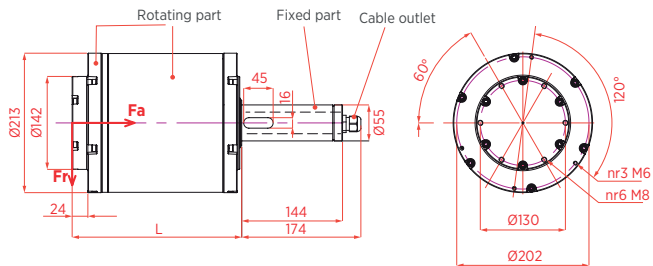

Fa Axial load
Fr Radial load

	L	Fa max	Fr max
	[mm]	[N]	
PMG-WG 185SC	182	1500	4100
PMG-WG 185MA	225	1500	4400
PMG-WG 185LA	269	1500	4200

PMG-WG 295

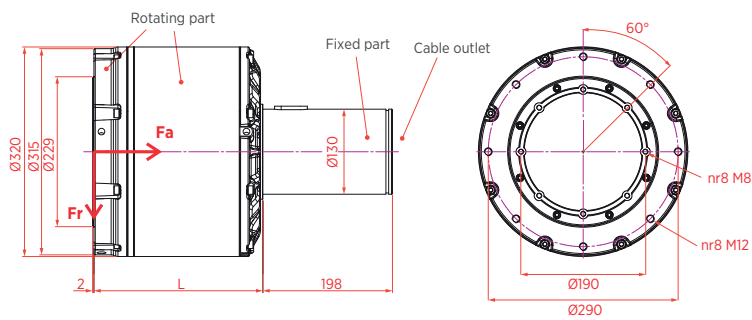

	L	Fa max	Fr max
	[mm]	[N]	
PMG-WG 295H	258	3000	6720
PMG-WG 295P	343	3000	7150

TAC

PMG-WG 185

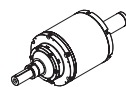
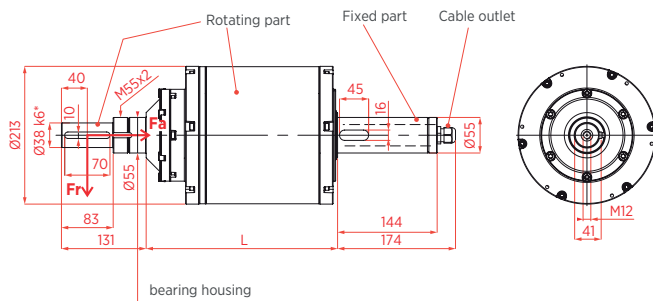

Fa Axial load
Fr Radial load

	L	Fa max	Fr max
	[mm]	[N]	
PMG-WG 185SC	219	1500	3100
PMG-WG 185MA	262	1500	3100
PMG-WG 185LA	306	1500	3100
PMG-WG 185XLB	449	1500	3100

B5

PMG-WG 185

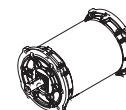
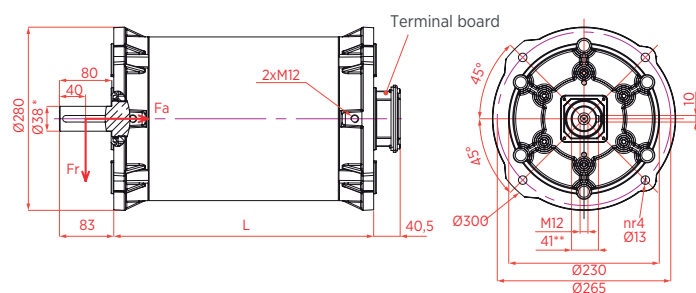

Fa Axial load
Fr Radial load

	L	Fa max	Fr max
	[mm]	[N]	
PMG-WG 185SC	310	1500	5700
PMG-WG 185MA	353	1500	5700
PMG-WG 185LA	397	1500	5700
PMG-WG 185XLB	540	1500	5700

* 032 on request
** 35 (shaft 032)

NSM S.r.l.

Via Lazio 5/b
36015 Schio | Vicenza | Italy

T +39 0445 595888
F +39 0445 595800

info@nsmsrl.it
www.nsmsrl.it



Technical data not binding: NSM reserves the right to modify the contents without prior notice.